



**FIBERSTARS**<sup>®</sup>  
Sustainable Technology in Lighting<sup>™</sup>



# 6004 SERIES

## INSTALLATION MANUAL

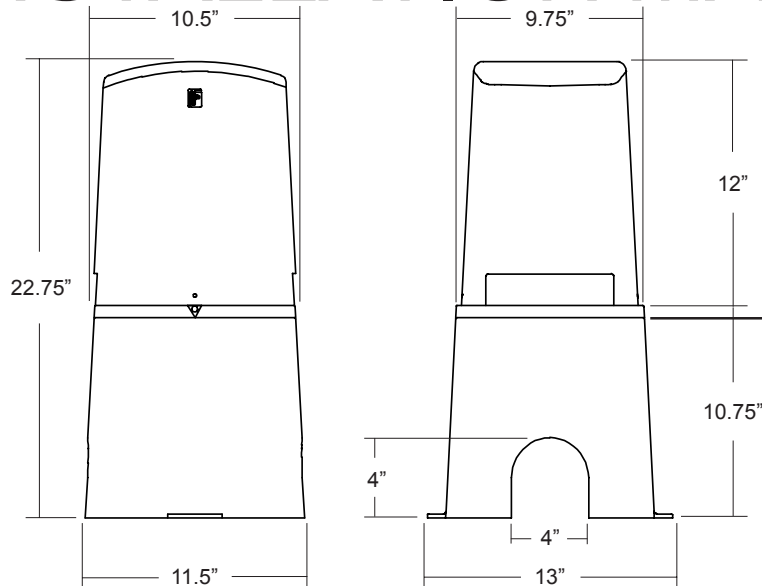

**MAXIMUM SOIL HEIGHT:**  
DO NOT ALLOW FILL TO  
EXCEED THIS LEVEL!

### SPECIFICATIONS

#### CONSTRUCTION

Case: High Impact Polycarbonate  
Ventilation: 110 cu ft/min air volume  
Acoustic rating: 50dB(A)  
Weight: 20 lbs.

#### ELECTRICAL

Voltage required: 120VAC 60Hz  
Power consumption: 200 Watts max  
Start current load: 4.4 amps  
Current usage: 1.8 amps

#### LAMP

Type: Metal-Halide, proprietary design  
Lamp life: 6000 hrs average  
Cool down restrike period: 3 minutes  
Replacement p/n: Y20-6000

**WARNING: DO NOT INSTALL  
WITHIN 1.5M (5 FT.) OF A POOL,  
SPA, OR HOT TUB.  
ADVERTISSEMENT: NE PAS IN-  
STALLER A MOINS DE 1,5 M D'UNE  
PISCINE OU D'UNE CUVE DE RE-  
LAXATION.**

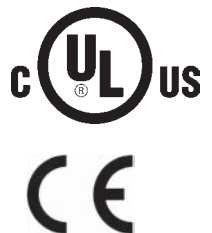

79-15022-00 Rev. C

# ELECTRICAL CONNECTIONS

**6004**

**120v 60HZ ONLY**

## TOGGLE SWITCH POSITIONS

### MANUAL CONTROL

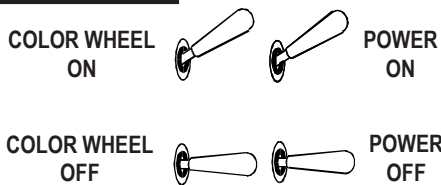

### EXTERNAL AUTO CONTROL



### OPTIONAL RM6000 CONTROL

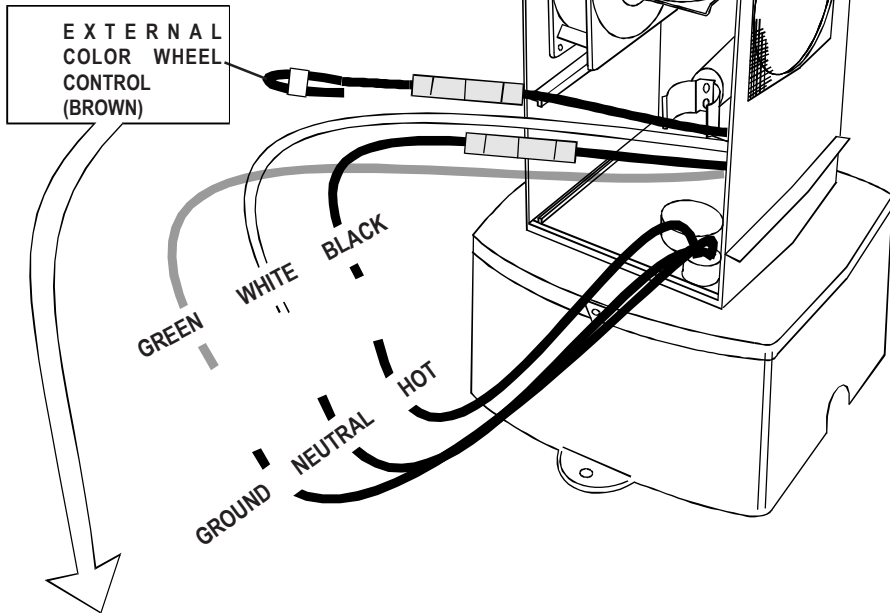
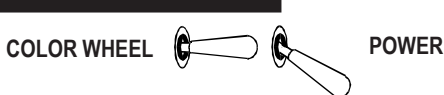

**EXTERNAL AUTO CONTROL HOOK-UP FOR COLOR WHEEL**  
For Jandy Aqualink, Compool, Aquadyne, etc.

Run a 120V hot wire to the illuminator from a second relay in the control's sub panel for the color wheel control. Connect this wire to the folded brown wire with fuse. Place the Color Wheel toggle switch in the bottom position.

## OPTIONAL RM-6000 WIRELESS REMOTE

1 Year warranty!

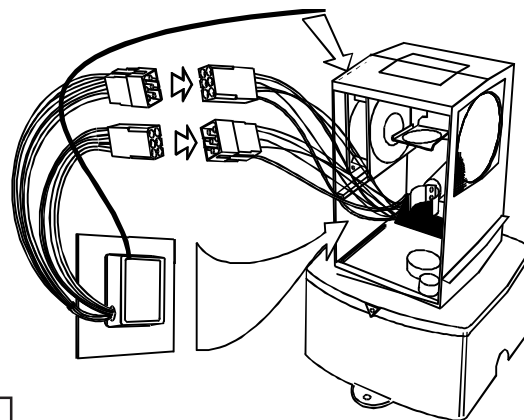
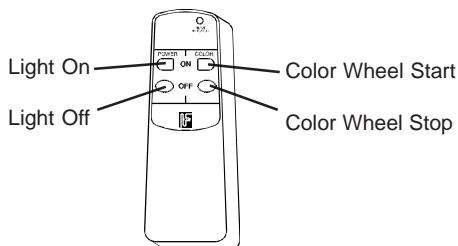

## TOGGLE SWITCH POSITIONS

### OPTIONAL RM-6000 CONTROL

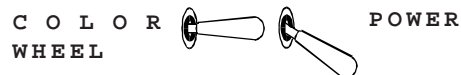

This RM-6000 Automatic Operating System package is specifically designed for the Lifetime illuminator™ fiber optic illuminator and should not be modified or adapted in any way. This is an electric component and should only be installed by a qualified technician. Please follow the instructions carefully. RANGE IS APPROXIMATELY 75 FEET DEPENDING ON CONDITIONS.

# INSTALLATION GUIDELINES

REFER TO THE DIAGRAM ON THE FRONT OF THIS MANUAL FOR THE FOLLOWING PROCEDURES

- 1) SEE OUR GENERAL INSTALLATION MANUAL FOR FIBER AND CONDUIT INSTALLATION IN THE POOL. THIS MANUAL COVERS THE 6000 SERIES ILLUMINATOR INSTALLATION ONLY.
- 2) CUT THE FIBER CONDUITS SO THEY WILL ENTER THE INSTALLATION BASE APPROXIMATELY HALF WAY. CUT THE ELECTRICAL CONDUIT SO IT WILL PROTRUDE PAST THE CONDUIT HOLE 1" OR LESS (FIG A.). PULL ALL FIBER OPTIC CABLES AT LEAST 12" THROUGH THE TOP OF THE INSTALLATION BASE.
- 3) FOLLOW THE PORT ASSEMBLY PROCEDURES ON THE BACK OF THIS MANUAL.
- 4) PLACE THE CHASSIS ON THE INSTALLATION BASE. SECURE THE ILLUMINATOR WITH THE TWO SCREWS SUPPLIED. SNAP THE PORT INTO THE CLIP ON THE CHASSIS. MAKE SURE IT SEATS FIRMLY INTO THE CLIP (FIG B.).
- 5) MAKE THE ELECTRIC CONNECTIONS AS SHOWN ON THE PREVIOUS PAGE. MAKE SURE NO WIRES INTERFERE WITH THE COOLING FAN OR COLOR WHEEL.
- 6) a) IF INSTALLING IN THE GROUND:  
BACKFILL HALF WAY UP THE INSTALLATION BASE. ALLOW AMPLE HEIGHT FOR TOP SOIL AND LANDSCAPING. DO NOT ALLOW THE VENTS ON THE BOTTOM OF THE ILLUMINATOR TO BE BLOCKED. THIS WILL CAUSE THE ILLUMINATOR TO OVERHEAT AND SHUT OFF.  
b) IF SURFACE MOUNTING:  
USE PROPER SECURING SCREWS FOR THE SURFACE TYPE YOU ARE ATTACHING TO, USING THE 2 HOLES PROVIDED ON THE BASE. EXAMPLE: FOR CONCRETE, USE PROPER CONCRETE SCREWS. FOR WOOD SURFACE, USE PROPER WOOD SCREWS

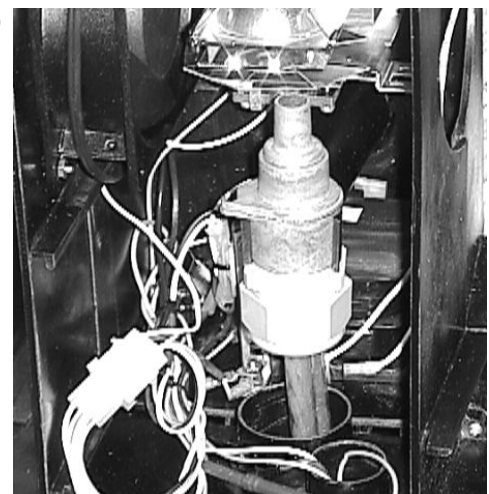
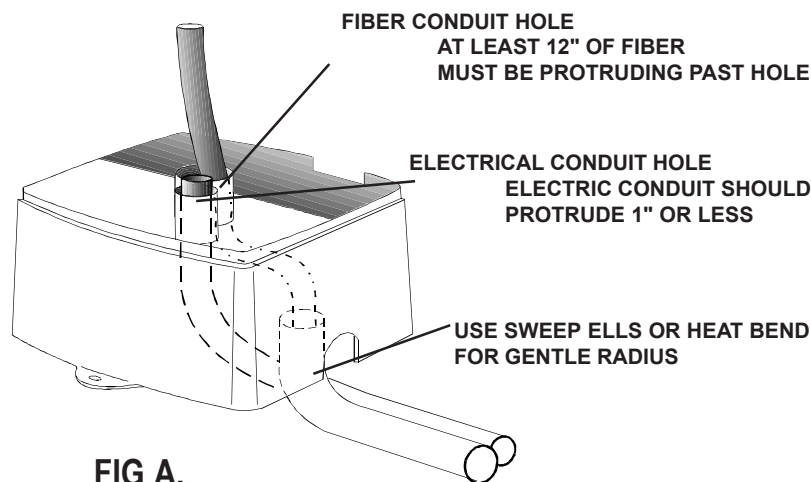

## APPROVED CONDUITS FOR USE WITH FIBER OPTIC CABLES

- White PVC conduit/ pipe SCH 40 or SCH 80
- Gray PVC Conduit/pipe SCH 40 or SCH 80
- Flexible PVC pipe
- Black poly pipe
- Any other suitable conduit

# PORT ASSEMBLY/FIBER TERMINATION

A) Insure that the total fiber count of all fiber tubings is 450 or less. If you have more than 450 individual fibers, you will need a second illuminator. The maximum capacity of the 6004 series port is 450 fibers.

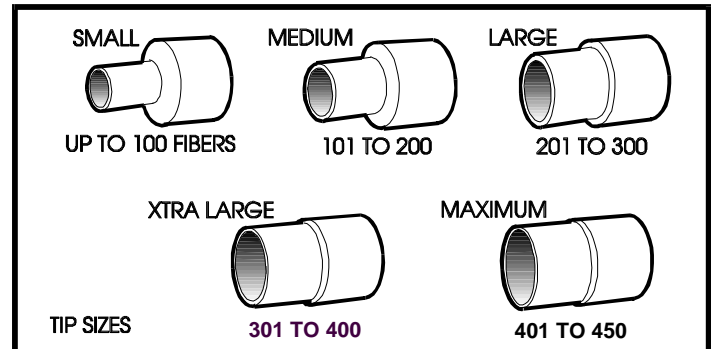

B) Insert the proper size tip into the port and twist with pliers to lock (fig. 1).

C) Strip back all fiber casings no less than 4 inches (fig. 2). Take care not to nick the fibers.

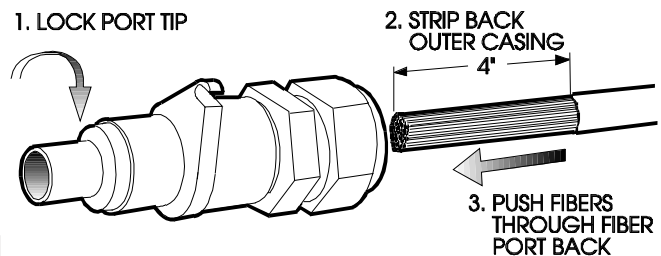

D) Insert the bare fibers into the port so ALL fibers protrude past the port tip (fig 3). Tighten the port compression nut down on the fiber casing (fig 4).

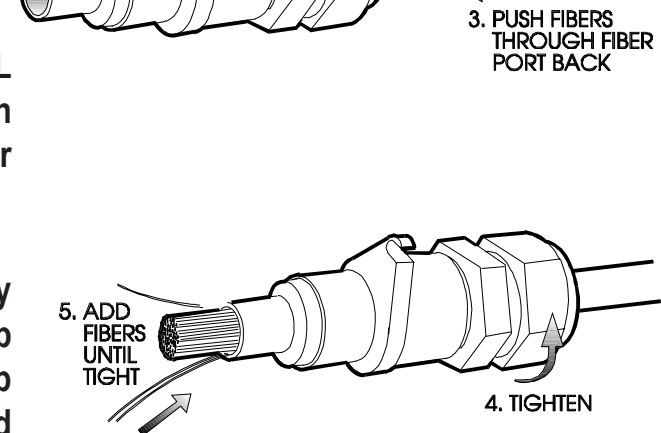

E) **IMPORTANT:** If the port tip is not completely full, insert scrap individual fibers into the tip until it is completely full (fig. 5). This will keep the lit fibers perpendicular to the lamp, and prevent the fibers from overheating.

F) Plug in the hot knife (p/n FS-118) and allow it to heat up. Apply firm downward pressure on the fibers, with the blade touching the port tip at a slight angle (fig 6). Do not saw at the fibers. Allow the heat of the knife to slowly trim the fibers. Ease the pressure as the knife almost completes the cut. Unplug the hot knife and place it in a safe place to cool.

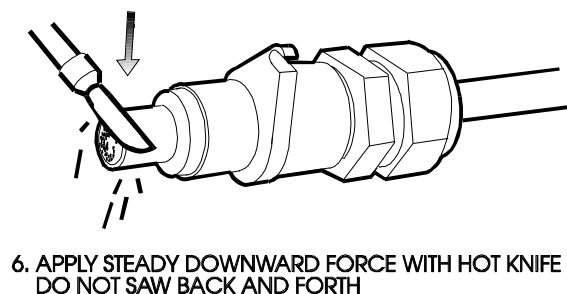

Fiberstars, Inc.

44259 Nobel Drive Fremont, CA 94538 USA  
(800) 327-7877 (510) 490-0719 Fax (510) 490-3247  
www.fiberstars.com